

Operating Instructions LabTower EDI

Art. no.: 07.4415
 Art. no.: 07.4430

Art. no.: 07.4445



Serial no.:

Read these Operating Instructions prior to starting to install and operate the system!

29.0233, Stand: 06.09 Rights to technical changes reserved!

Company
TKA Wasseraufbereitungssysteme GmbH
Stockland 3
D-56412 Niederelbert

EC Declaration of Conformity

acc. to EC Directive 98/37/EC
- Machines Directive -

We herewith declare that the design and construction of the machine named below, and the versions of it that we have introduced into the market, conform to the fundamental safety and health requirements of EC Directive 98/37/EC.

This declaration becomes invalid when changes which were not agreed to by us are made to the machine.

Description of the machine:	Ultrapure water system
Machine type:	LabTower EDI
Article number:	07.4415 07.4430 07.4445
Applicable EC Directives:	EC Machines Directive (98/37/EC) EC Low Voltage Directive (73/23/EEC) EC Electromagnetic Compatibility Directive (2004/108/EC)
Standards applied:	DIN EN ISO 12100-1 DIN EN ISO 12100-2 DIN EN 60204-1 DIN EN 55011 DIN EN 50082-2

Niederelbert, 18. June 2007

Authorized Manufacturer's Representative

Preface

Dear Sir or Madam,

in deciding to purchase a Ultrapure water system of type **LabTower EDI** you have selected a high-quality product.

Thank you for the confidence you have placed in us.

Before you start to install and operate your Ultrapure water system, please carefully read the information on how it is to be properly installed and operated that is given in these Operating Instructions.

This is particularly important, as we, the manufacturer, cannot accept liability for any damage occurring as a result of improper operation of this system, or from use of it for other than the intended purpose.

Niederelbert, 18 June 2007

1. Contents

Preface.....	3
1. Contents.....	4
2. Notes on the Operating Instructions	6
3. Transport and packaging	7
3.1 Examination on receipt.....	7
3.2 Complaints	7
3.3 Packaging and return shipment.....	7
4. Safety instructions.....	8
5. Extent of delivery	9
6. Technical specifications	10
7. Flow chart	12
7.1 How the system functions	15
8. The installation area.....	17
9. Putting into operation	18
10. Operating elements.....	20
11. System control	21
11.1 User menu.....	21
11.1.1 Permeate conductivity:	21
11.1.2 Product water conductivity:.....	22
11.1.3 Ultrapure water limiting value:	22
11.1.4 Operating hours:	23
11.1.5 Pretreatment operating hours:	23
11.1.6 Cleaning:.....	23
11.1.7 Disinfection:	24
11.1.8 Fault storage:.....	24
11.1.9 Unlocking the system:.....	25
11.2 OEM menu	29
11.2.1 Maximum temperature:.....	29
11.2.2 Disinfectionszeit:	30
11.2.3 Recirculation time:	30
11.2.4 Rinsing time:	30
11.2.5 Interval rinse time:	31

11.2.6 Real-time clock:.....	31
11.2.7 Sending interval:	31
11.2.8 Language:	32
11.2.9 Switching units:	32
11.2.10 Switch off of temperature compensation:.....	32
11.2.11 Adjusting the circuit hysteresis of the float switch:	33
11.2.12 Programme choice UPW/ PW/ EDI:	33
11.2.13 Entering the type and serial number of the system:	33
11.3 Printer output	34
11.3.1 Standard message:	34
11.3.2 Code message:	34
11.3.3 Fault message:.....	34
12. Maintenance	35
12.1 Rinsing the membrane	36
12.2 Replacing the pre-treatment.....	37
12.3 Replacing the RO-membrane.....	38
12.4 Changing the Ultrapure water module.....	39
12.5 Disinfection procedure.....	40
13. Trouble shooting.....	43
14. List of replacement parts	46
15. Accessories	48
16. Consumable materials:.....	48
17. Terminal assignment	49
18. Maintenance record.....	51

2. Notes on the Operating Instructions



Danger notes are emphasized by a warning triangle.



Important notes are marked with an information sign.

The information provided in these Operating Instructions is only valid for the system whose serial number is written in on the front page.



Please write the serial number of your LabTower system on the front page.

* You can find the serial number on the type plate of your Ultrapure water system.

For all inquiries and replacement parts orders, it is important that you correctly state the following:

- **Serial no.**

- **Article no.**

3. Transport and packaging

TKA Ultrapure water systems are carefully checked and packed prior to shipment, but there is nevertheless always a possibility that damage to them could occur during shipment.

3.1 Examination on receipt

- Check the completeness of the delivery against the shipping papers.



Is the packaging damaged?

- Check the system for damage.

3.2 Complaints

Should the system have been damaged during transport:

- Immediately contact the post office, railway or forwarding agent*.
- Keep the packaging, including the outer cardboard box, for a possible inspection and/or return shipment.

3.3 Packaging and return shipment

Whenever possible, use the original packaging and packaging materials.

Should this no longer be available:

- Pack the system in packing film and in a strong cardboard box so that it is held shock-proof.



* **Complaints are only valid for 6 days (after receipt of the goods).
After this time, the right to claim for damages expires.**

4. Safety instructions

- Your LabTower EDI system is a modularly constructed Ultrapure water system that serves exclusively for the purification of tap water.
- Do not start to install and operate the system until you have read through the corresponding information that is given in these Operating Instructions.
- Note that the manufacturer is freed from all liability for damages that result from improper operation of the system, or from use of it for other than the intended purpose.
- The CE-Mark is invalidated should constructional changes be made to the system or products of other manufacturers be installed in it.
- Protect the system from frost. The temperature in the area in which the system is installed must be at least +2°C and must not exceed + 35°C.
- Observe all applicable and appropriate regulations and requirements, including current accident regulations, and the statics of the flooring in the area of installation of the system.
- The feedwater pressure must be at least 2 bar and at most 6 bar. If the feedwater pressure is higher, install an additional pressure reducer.
- DIN EN 1717 requires that water purification systems be equipped with a safety device that protects the drinking water system from contamination.
- A 230V/50Hz electric safety socket with earth contact must be planned.
- The installation area must have a drain at floor level with at least DN 50 pipe. The manufacturer will otherwise not accept any liability for water damage. Should no such drain be available, then we recommend that a water watcher (art.-no. 16.0129) must be installed.
- Gravity fall to the waste drain must be ensured.
- After long standstill periods (e.g. annual holidays) the system must be rinsed and, if appropriate, disinfected. Refer to the "Cleaning and disinfection" section for details.
- When selecting the installation area and installing the system, make sure that there is sufficient working area for convenient operation of it.
- Never look directly at a switched-on UV-lamp, as ultraviolet light can impair eyesight! The UV-lamp is only to be changed by TKA or by TKA authorized personnel.
- The guarantee is valid for a period of 12 months.

! For your own safety, please observe the safety precautions given above !

5. Extent of delivery

The LabTower EDI Ultrapure water system consists of:

1 x	LabTower EDI	Article no. 07.44__
1 x	Assembly kit consisting of:	Article no. 25.0086
1 x	Ultrapure water module	Article no. 09.2005
1 x	Prefilter cartridge 5µm + activated carbon, 5"	Article no. 06.5203
1 x	Hardness stabilization, 5"	Article no. 06.5453
1 x	Connector	Article no. 14.0402
1 x	Fine filter 1 µm, 10"	Article no. 06.5101
1 x	Connecting kit	Article no. 25.0085
1 x	Operating Instructions	Article no. 29.0233
	Connecting kit consisting of:	Article no. 25.0085
3 x	Connecting hoses, PE, Ø8/Ø6 x 3m	Article no.: 18.0036
2 x	POM Insert	Article no.: 14.0189
2 x	Gasket 3/4"	Article no.: 21.5008
2 x	Union nut, R 3/4"	Article no.: 14.0003
2 x	Screw connector, d8-1/4"	Article no.: 14.0075



Please check the parts delivered against this list. Contact the manufacturer should a part be missing.

6. Technical specifications

Demands made on the raw water	
Source	Potable tap water softened or hardness stabilized.
Blocking index (SDI)	< 3, with higher values, an upstream pretreatment (article no. 09.4000) is to be installed.
Conductivity	<1500 µS/cm
Prefiltration	5µm + activated carbon + hardness stabilization
Free chlorine	< 0.1 mg/Litre
Manganese content	< 0.05 mg/Litre
Iron content	< 0.05 mg/Litre
Colloid index	< 3
ph-Range	4 - 11
Temperature	2 - 35 °C
Pressure	2 - 6 bar

Product water quality ASTM I (dispensing valve)			
		Standard	UV (option)
Conductivity	µS/cm	0.055	0.055
Resistance	MΩxcm bei 25°C	18.2	18.2
TOC	ppb	5 - 10	1 - 5
Bacteria	KBE/ml	< 1	< 1
Particles	> 0,2 µm	< 1/ml	< 1/ml
Flow rate	L/min	1.5	1.5
Typical volume taken	10 L/day		

Product water quality ASTM II (tank quality)			
	LabTower EDI 15	LabTower EDI 30	LabTower EDI 30
Retention quota, salts	Ø 98 %	Ø 98 %	Ø 98 %
Retention quota, bacteria and particles	99 %	99 %	99 %
Conductivity	0.067 – 0.1 µS/cm	0.067 – 0.1 µS/cm	0.067 – 0.1 µS/cm
Resistance MΩxcm bei 25°C	15 – 10	15 - 10	15 - 10
Performance	15 L/h	30 L/h	45 L/h

Dimensions	
Height	1500 mm
Width	450 mm
Depth	580 mm
Weight, empty	58 kg
Operational weight (with full tank)	158 kg

Cell constants of the measuring cells	
Conductivity, permeate	0.16 cm ⁻¹
Conductivity, product water	0.01 cm ⁻¹
Conductivity, ultrapure water	0.01 cm ⁻¹

Water connections	
Raw water inlet	Hose, 8 mm od / R3/4"
Concentrate outlet	Hose, 8 mm od
Ultrapure water outlet	Hose, 8 mm od

Electrical connections	
Voltage	230 V
Frequency	50/60 Hz
Power consumption	< 0.2 kW
Serial interface	RS 232

7. Flow chart

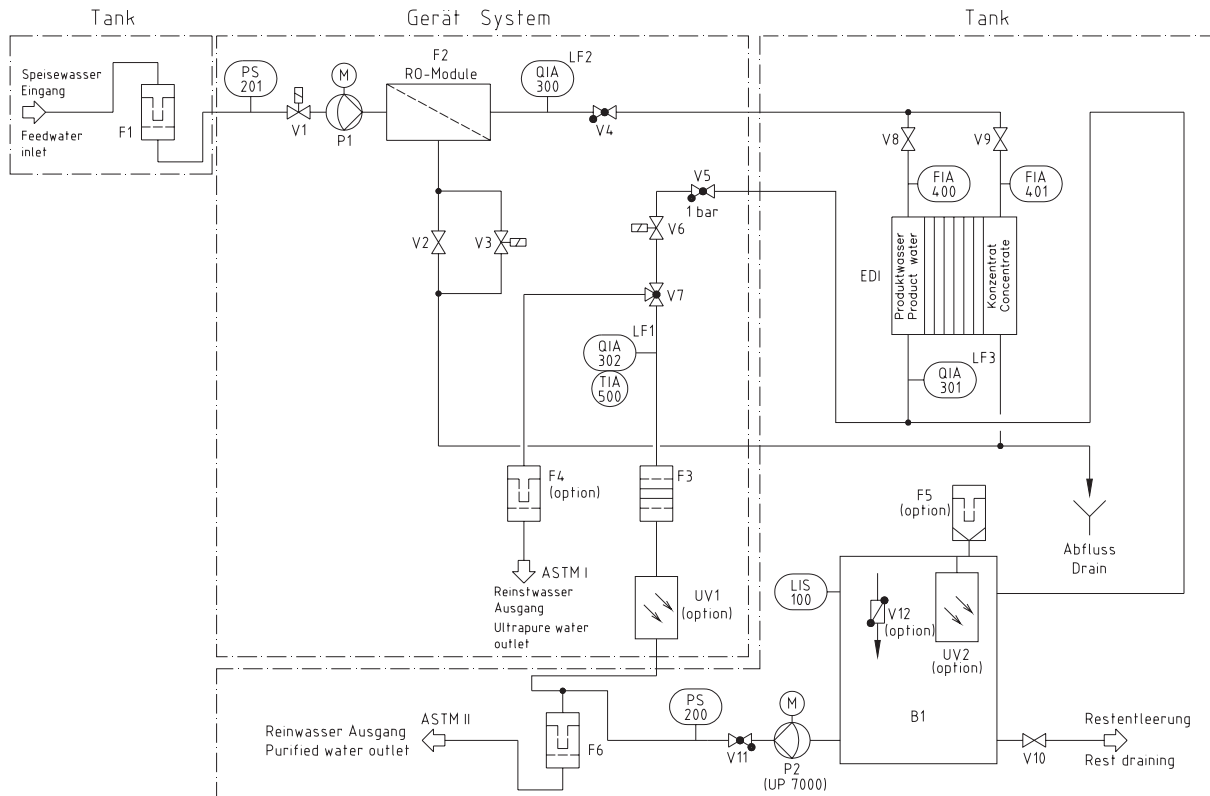

- | | |
|----------------------------------------------------------------------------------------------|----------------------------------------------------------------------------------------------------------------------------|
| B1 Storage tank: | Stores the product water produced. |
| F1 Prefilter, 5µm + activated carbon and hardness stabilisation (not with upstream softener) | Prevents the penetration of particles > 5µm and too high chlorine concentrations.

Stabilizes calcium and magnesium. |
| F2 RO-Module: | Semipermeable, thin-film, composite, spiral wound membrane. |
| F3 Ion exchanger: | Removes inorganic ions and traces of dissolved organic substances. |
| F4 Ultrafiltrationcapsule: charged (option) | Retains particles > 0,2µm. |
| F5 Sterile vent filter or Sterile vent filter + CO ₂ Adsorber (option) | Prevents the penetration of airborne bacteria and particles > 0,2 µm. |
| F6 Fine filter
Sterile filter (option) | Retains particles > 1µm.
Retains particles > 0,1µm. |

FIA400 Product flow meter, EDI cell:	Permanently shows the amount of pure water that is fed into the EDI cell (product inlet)
FIA401 Concentrate flow meter, EDI cell:	Permanently shows the amount of pure water that is fed into the EDI cell (concentrate inlet)
LIS100 Float switch:	Determines the filling level in the tank.
P1 Pressure booster pump:	Raises the input pressure to the required operating pressure.
P2 Recirculation pump::	On withdrawal, pumps ultrapure water through dispensing valve (V7) and sterile filter (F4) to the ultrapure water outlet, as well as through filter (F6) to a user. During interval switching, pumps ultrapure water back through the system via UV-lamp (UV1) and ion exchanger (F3).
PS200 Pressure switch:	Switches pump (P2) on when ultrapure water is withdrawn from tank (B1), and switches the pump off when dispensing valve (V7) is closed.
PS201 Pressure switch rawwater:	Switches the system off when the feedwater inlet pressure is too low.
QIA300 Permeate conductivity measuring cell:	Measuring device for the determination of the conductivity (after RO) as parameter for the permeate quality.
QIA301 Product water conductivity measuring cell:	Measuring device for the determination of the conductivity (after EDI) as parameter for the product water quality.
QIA302 Ultrapure water conductivity measuring cell:	Measuring device for the determination of the conductivity (after ultrapure water module) as parameter for the ultrapure water quality.
UV1 UV-photooxidation: (option)	Reduces the content of bacteria and other microorganisms.
UV2 UV-Disinfection: (option)	Reduces the content of bacteria in the water and so serves to prevent bacterial growth and the formation of a biofilm on the inside surfaces of the storage tank.
V1 Feedwater solenoid valve:	Is closed during stand-by and standstills. It prevents water from flowing into the system when it is not in operation.
V2 Pressure hold valve:	Serves to adjust the operating pressure and the WCF-rate (see section 7.1).
V3 Rinsing solenoid valve:	Opens for cleaning of the membrane prior to ultrapure water-production, after pure water production and at least every 12 hours.
V4 Check valve:	Prevents pure water from being pressured back in the RO-module.
V5 Check valve:	Prevents ultrapure water from flowing back into the system.

V6 Recirculation solenoid valve:	Opens for recirculation.
V7 Dispensing valve:	Allows ultrapure water to be withdrawn.
V8 Regulating valve, product, EDI cell:	Valve for adjustment of the amount of pure water that is fed into the EDI cell (product inlet).
V9 Regulating valve concentrate, EDI cell:	Valve for adjustment of the amount of pure water that is fed into the EDI cell (concentrate inlet).
V10 Residual drainage:	Allows complete emptying of the tank.
V11 Check valve::	Prevents ultrapure water from flowing back into the tank.
V12 Sterile tank overflow (option):	Prevents the penetration of bacteria and other micro-organisms.

7.1 How the system functions

When the ON/OFF key is pressed, the system starts running either in the operating mode or in the stand-by mode, according to the float switch.

The feed water flows with a maximum pressure of 6 bar into the system.

Pressure switch PS 201 checks the available inlet feedwater pressure and switches the system off should this be below the minimum pressure.

Feedwater solenoid valve (V1) is closed when the system is at stand-by or at a standstill. This prevents feedwater from flowing into the system when it is not in operation and so protects storage tank (B1) from overflowing.

Semi-permeable membrane (F2) retains all salts dissolved in the water up to the specified retention quota. The molecular size of the membrane pores is so small, that 99% of bacteria, pyrogens and particles are also removed from the feedwater.

The pure water flows now over the pure water measuring cell (QIA300) by the electrode ionization into the storage tank. The conductivity measuring cell (QIA301) measures the conductivity of the product water.

Recirculation pump (P2) pumps the ultrapure water from storage tank (B1) through the special conductivity measuring cell (QIA301) with temperature compensation (TIA500) to dispensing valve (V7) as well as through filter (F6) to a user. The conductivity measuring probe determines the conductivity and the temperature of the ultrapure water subsequent to UV-photooxidation* (UV1) and ion exchanger (F3). The measured values can be called in the microprocessor system control.

Recirculation pump (P2) runs every 15 minutes to recirculate the water that is in storage tank (B1) through the system. The time interval begins 10 minutes after switch-on to avoid dry-running of recirculation pump (P2).

* Option



Valve (V2) has been pre-adjusted at the factory. A change in the adjustment of this valve could result in damage to the reverse osmosis module! Because of fluctuations in the feedwater temperature and pressure, the adjustment of the pressure hold valve and the concentrate flow that it governs must be checked and re-adjusted if necessary, on putting the system into operation and at regular intervals thereafter. The measured values must be recorded in the maintenance record.

Concentrate flow for LabTower EDI				
Check and adjust at least 1x monthly				
System	Permeate-flow [l/h]	Concentrate-flow RO [l/h]	adjustable up to [%]	Concentrate-flow EDI [l/h]
LabTower EDI 15	20	min. 60	40	2
LabTower EDI 30	40	min. 60	40	4
LabTower EDI 45	50	min. 60	40	5

Your Ultrapure water system is equipped with automatic flushing. Flushing is carried out when the system is switched on, at the end of each production, and also every 12 hours. For this, rinsing solenoid valve (V3) is opened and the strong flow of water across reverse osmosis module (F2) then flushes coarse particles and other contaminants away from the surface of the membranes and carries them with it to drain.

This automatic flushing has a positive effect on the service life of the reverse osmosis module.

An additional advantage of automatic flushing is that it prevents bacterial growth from occurring in the reverse osmosis module when the system is at a standstill for a long time. For this reason, we highly recommend that you leave the system switched on over the weekend and during holiday times, so that the 12 hour flush can effectively guard against bacterial growth.

8. The installation area

The following criteria must be taken into consideration when choosing the installation area.

- ⇒ Minimum temperature in the installation area: + 2°C - +35°C.
- ⇒ The surface that your pure water system is to be stood on must be strong enough to support it (for weight, see "Technical Specifications").
- ⇒ A floor drain with waste pipe of DN 50 size (38.5 mm id) is required. Should this not be available, then a water watcher (article no.: 16.0129) must be installed to protect against damage from water flooding!
- ⇒ An unrestricted gravity flow of concentrate to the floor drain is obligatory.
- ⇒ An electrical socket appropriate to the voltage given on the type plate of the system must be positioned directly alongside the system. The safety fuse must be appropriate for the power required (see "Technical Specifications").
- ⇒ Ensure that there is sufficient working room around the system.
- ⇒ An R ¾"R male thread tap water connection which can be shut off must be installed in the direct vicinity of the system.
- ⇒ Easy access to this must be ensured.

9. Putting into operation

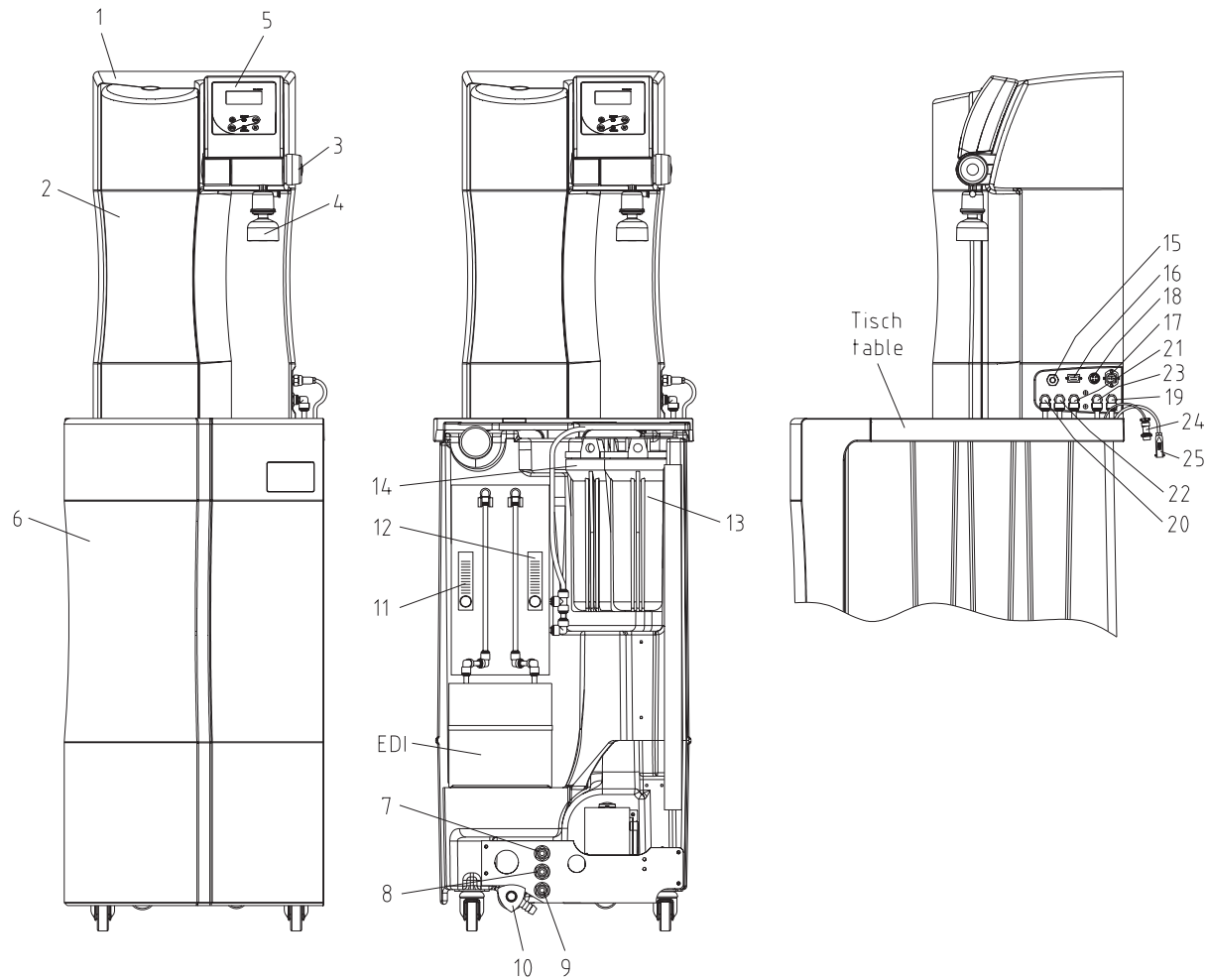

- | | | | |
|-----|--------------------------------------------------------|-----|---------------------------------------------------|
| 1) | LabTower EDI Ultrapure water system | 15) | Power supply 230V/50Hz |
| 2) | Front hood, removable | 16) | Printer connector |
| 3) | Rotary knob for pure water dispensing/dispensing valve | 17) | Power supply EDI 230V/50Hz |
| 4) | Ultra filtration capsule (option) | 18) | Power supply for the pressure pump/tank |
| 5) | Operating unit | | Level control connector |
| 6) | Front cover, storage tank | 19) | Feedwater connector Ø8 mm |
| 7) | Feedwater inlet | 20) | Permeate connector Ø8 mm |
| 8) | Concentrate outlet | 21) | Pure water connector (in) Ø8 mm |
| 9) | Pure water outlet | 22) | Concentrate connector Ø8 mm |
| 10) | Residual water drainage | 23) | Pure water connector (out) Ø8 mm |
| 11) | Product flow rate meter | 24) | Power supply connector for the pressure pump/tank |
| 12) | Concentrate flow rate meter | | Level control connector |
| 13) | Pretreatment | 25) | Power supply EDI 230V/50Hz |
| 14) | Sterile or fine filter | | |

1. Place the Ultrapure water system on the table of the storage tank. Connect the hoses positioned at the table by putting the connectors in with the appropriate connections (19-23) at the equipment.
2. Remove the covering hood (6) of the storage tank.
3. Turn the filter housing of the pre-treatment (13) loosely. Insert the pre-treatment unit contained when assembling (hardness stabilization, pre-filter and connector) into the filter housing and screw this again firmly (see chapter „Change of the pre-treatment “).
4. In the case of use of the optional sterile or fine filter you turn the filter housing (14) loosely. Insert the filter into the filter housing and bolt this on again.
5. Connect the $\text{Ø}8 - \frac{3}{4}$ “ female thread feedwater hose supplied to the feedwater inlet (7) of the storage tank and to a water tap that can be turned off. The connecting hose is marked “Feedwater“.
6. Connect the $\text{Ø}8$ concentrate hose supplied to the concentrate outlet (8) of the storage tank and to the drain provided on-site. The concentrate hose is marked „Concentrate“.
Caution! The concentrate must be able to flow under free gravity fall to the drain!
7. Plug the 4-pin plug of the level control system (storage tank), marked „Niveau“, in the 4-pin socket (18) of the Ultrapure water system and screw the milled nut of the plug tight. Connect the plug (power supply EDI, 230 V), marked “EDI 230V”, to coupling (17) of the Ultrapure water system. Fix the plug by firmly pressing the clamp.
8. Screw the optional ultra filtration capsule (4) into the withdrawal tap G1/4 “.
9. Now fit the hose of the $\text{Ø}8$ mm sterile overflow to the overflow on the back of the tank and connect it to the drain.
10. Ensure that residual water drainage (10) is turned closed.
11. Check the feedwater pressure; it must be within the permissible pressure range (see Technical specifications).



Before you now switch the system on, read through the rinsing out procedure for reverse osmosis membranes packed with preserving agent in the „Rinsing the membrane“!

12. Plug the line plug in and switch the Ultrapure water system on with the on/off key on the operating unit (5).
13. Check that all connections are leak-tight.
14. Replace the covering hood on the storage tank.

After a short rinsing phase, your system begins to produce pure water into the storage tank.

10. Operating elements

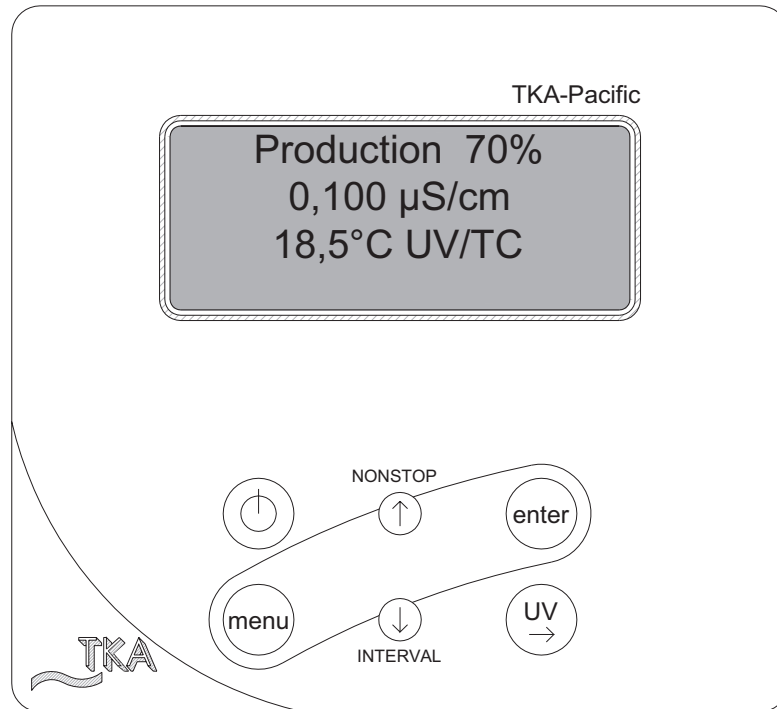

Switches the system on or off

NONSTOP



Switches "Nonstop" operation on or, in the menu, increases a value on display



Confirms the value shown in a menu point



Switches the menu to the next menu point



INTERVAL

Switches "Interval" operation on or, in the menu, decreases a value on display



Switches the UV-lamp on or, in the menu, allows you to select the position in a number that you wish to change

11. System control

General information

When the ON/OFF key is pressed, the system starts running either in the operating mode or in the stand-by mode, according to the float switch.

The operating mode and the volume contained in the tank are shown in line 1 of the display and the measured value of the permeate is shown in line 2.

Should a fault exist, then a fault message is given out across the potential-free output and is shown in line 4 of the display. In the case of several simultaneous faults, then they are alternately displayed.

11.1 User menu

All of the measured values, operating times and limiting values that are relevant for the user can be set and read in this menu.

A press on the menu-key brings you into this menu. Each further press on the menu-key moves you on from one menu prompt to the next.

Settings can be changed with the arrow keys and, when the appropriate value has been set, be confirmed by pressing the Enter-key, which also takes you to the next menu prompt.

To simplify changing settings, a press on the UV-key allows you to select a certain number in a numerical value that you wish to change. The arrow-keys can then be used to set a number from 0 to 9 at this selected position.

11.1.1 Permeate conductivity:

A single press on the menu-key allows the permeate conductivity to be read and the limiting value for the permeate conductivity to be set. Should this limiting value be exceeded, then the "*Lim.val.permeate*" fault message is displayed flashing in the 4th line of the display.
(Measuring point LF 2)

Limiting value setting range: 0.1 – 150.0 $\mu\text{S/cm}$

Basic setting: 50 $\mu\text{S/cm}$

Settings above 150.0 $\mu\text{S/cm}$ result in the limiting value being switched off. The word "*Off*".appears in the display.

The display shows:

Permeate 12.0 $\mu\text{S/cm}$ Lim.val.permeate 50.0 $\mu\text{S/cm}$

11.1.2 Product water conductivity:

A second press on the menu-key allows the product water conductivity to be read and the limiting value for the product water conductivity to be set. Should this limiting value be exceeded, then the "Lim.val. EDI" fault message is displayed flashing in the 4th line of the display.

(Measuring point LF 3)

Limiting value setting range: 0.1 – 150.0 $\mu\text{S/cm}$
Basic setting: 5 $\mu\text{S/cm}$

Settings above 150.0 $\mu\text{S/cm}$ result in the limiting value being switched off. The word "Off".appears in the display.

The display shows:

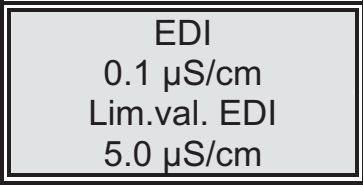

EDI
0.1 $\mu\text{S/cm}$
Lim.val. EDI
5.0 $\mu\text{S/cm}$

11.1.3 Ultrapure water limiting value:

A third press on the menu-key in this menu allows the ultrapure water limiting value to be set. Should this limiting value be exceeded, then the "Lim.val.ultrapure" fault message is shown (Measuring point LF 1).

Limiting value setting range: 0.055 – 9.999 $\mu\text{S/cm}$
Basic setting: 0.1 $\mu\text{S/cm}$

Settings above 9.999 $\mu\text{S/cm}$ result in the limiting value being switched off. The word "Off".appears in the display.

The display shows:

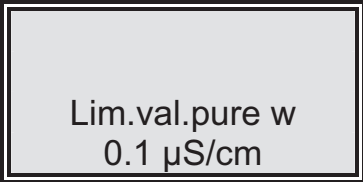

Lim.val.pure w
0.1 $\mu\text{S/cm}$

11.1.4 Operating hours:

A fourth press on the menu-key in this menu allows the operating hours of the UV-lamp and the reverse osmosis pump to be displayed. The operating hours counter for the UV-lamp registers the total length of time for which the lamp was switched on. When the maximum operating time is reached, the "UV-time" fault message is triggered. The limiting value is set in the OEM menu. There is no limiting value for the reverse osmosis pump.

The display shows:

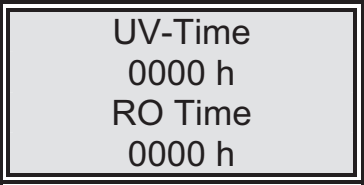

UV-Time
0000 h
RO Time
0000 h

12.1.5 Pretreatment operating hours:

A fifth press on the menu-key in this menu brings the operating hours of the pre-treatment cartridge to display.

The limiting value for this operating time is set in the UV menu. The fault message that is displayed when the limiting value is exceeded is "Pretreatment".

The operating hours of the pretreatment are counted whenever the reverse osmosis pump is running.

The display shows:

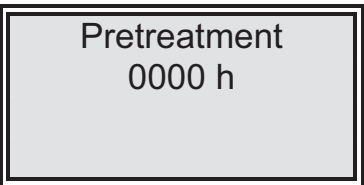

Pretreatment
0000 h

11.1.6 Cleaning:

A sixth press on the menu-key in this menu allows cleaning to be carried out should there is a need for it. The cleaning process is triggered by pressing the Enter-key. The pump then starts and the inlet solenoid valve and the rinsing solenoid valve open for a period of 60 seconds.

During cleaning, no faults or measured values are displayed. When the cleaning process has finished, the system is in the last operating mode (operating or stand-by).

The remaining cleaning time is displayed during cleaning.

The display shows:



During cleaning, the display shows:

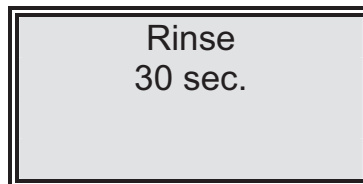

11.1.7 Disinfection: (not active in this version)

The display shows:

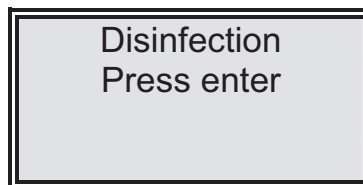

11.1.8 Fault storage:

A eighth press on the menu-key in this menu calls the fault storage prompt. Confirmation of this with the Enter-key allows the fault storage to be looked through. The display can show two faults at once, each with time and date. Pressing an arrow key allows previous or following faults to be displayed.

Pressing the menu-key or the Enter-key returns the system to the last operating mode.

The display shows:

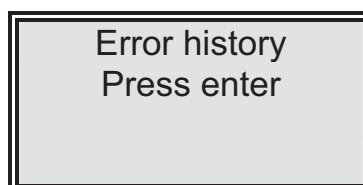

The fault storage display shows:

14.03.04 14.30 Lim.val.permeate 14.03.04 15.30 Pretreatment

11.1.9 Unlocking the system:

An ninth press on the menu-key in this menu brings you to the “Code” menu. To prevent unauthorized access to the settings in the system control, changes to the settings can only be carried out when the correct code from the Assignment Table that follows is entered and confirmed with the Enter-key. The unlocking remains active for 5 minutes. Each access via the code is typed out by the printer (RS 232), complete with date, time and abbreviated code number (“Code 0001” corresponds to code 150, “Code 0002” to code 250 etc.).

The display shows Menu-point F:

Code Press enter 0000



Code numbers can be assigned to individual persons according to the Assignment Table that follows on the next page.
Remove this page from the Operating Instructions and store it where it is safe from unauthorized viewing.

Assignment Table
for code numbers allowing the system to be unlocked

Code no.	Printer output	Person
150	0001	
250	0002	
350	0003	
450	0004	
550	0005	
650	0006	
750	0007	
850	0008	
950	0009	

11.2 OEM menu

Basic settings and limiting values can be changed in this menu.
To make changes in the OEM menu, the system control must previously be unlocked (see "Unlocking the system").

Calling the OEM menu:

Simultaneous pressing of the Interval-key and the Nonstop-key calls the OEM menu. Following this, the prompt "OEM menu Press enter" appears. When this is confirmed with the Enter-key, the first menu prompt can be worked on. To simplify changing settings, press the UV-key to select the number in a value which you want to change. Using the arrow keys now allows a number from 0 to 9 to be entered at that position.

A press on the menu-key takes you to the next menu prompt.

The OEM menu prompt display shows:

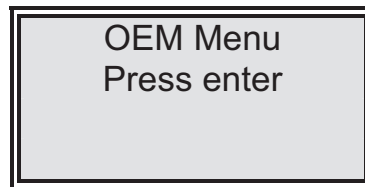

11.2.1 Maximum temperature:

A single press on the menu-key:

The maximum temperature to which the system can be exposed can be set in this menu. When this temperature is exceeded, the "max. Temperature" fault message is triggered. Settings above 50 °C cause the limiting value to be suppressed and the word „off“ appears in the display. It is shown in the 4th line of the display.

Basic setting: 50 °C

Setting range: 1 - 50 °C

The display shows:

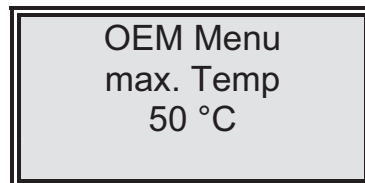

11.2.2 Disinfectionszeit:

A second press on the menu-key:
(not active in this version)

The display shows:

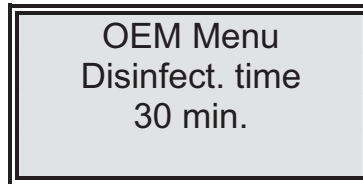
**11.2.3 Recirculation time:**

A third press on the menu-key:

The recirculation time is shown in this menu.

Basic setting: 15 min.
Setting range: 1 - 30 min.

The display shows:

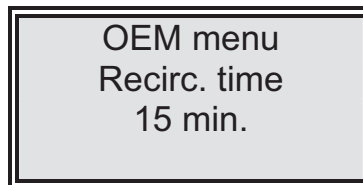
**11.2.4 Rinsing time:**

A fourth press on the menu-key:

The rinsing time is set in this menu.

Basic setting: 0.5 sec.
Setting range: 0.1 - 30 sec.

The display shows:

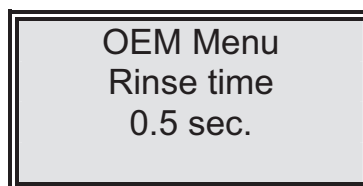

11.2.5 Interval rinse time: A fifth press on the menu-key:

The interval rinse time is set in this menu. Rinsing is carried out for this time period when the operating mode is changed, between stand-by and operation and every 12 hours.

Basic setting: 2 sec.
Setting range: 1 - 30 sec.

The display shows:

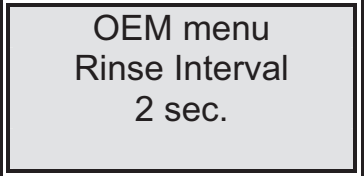

OEM menu
Rinse Interval
2 sec.

11.2.6 Real-time clock: A sixth press on the menu-key:

The real-time clock is set in this menu.

Basic setting: The actual date
Setting range: 1 - 12 months, 1 - 31 days, 0 - 24 h, 0 - 60 min.

The display shows:

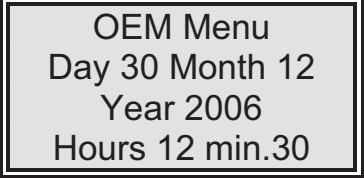

OEM Menu
Day 30 Month 12
Year 2006
Hours 12 min.30

11.2.7 Sending interval: A seventh press on the menu-key:

In this menu, the sending interval for transmissions of measured values and fault messages to the RS 232 interface is set.

Basic setting: 8 hours
Setting range: 0.5 - 12 hours

The display shows:

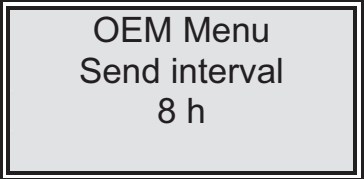

OEM Menu
Send interval
8 h

11.2.8 Language:**An eighth press on the menu-key:**

The language in which texts are displayed is set in this menu. Choice of English, German or French.

Basic setting: English

The display shows:



OEM menu
Language
English

11.2.9 Switching units:**A ninth press on the menu-key:**

In this menu, a choice can be made as to whether the specific electric resistance or the conductivity is to be displayed.

Basic setting: Conductivity $\mu\text{S/cm}$
Setting range: Conductivity $\mu\text{S/cm}$,
Specific electric resistance $\text{M}\Omega \text{ cm}$

The display shows:

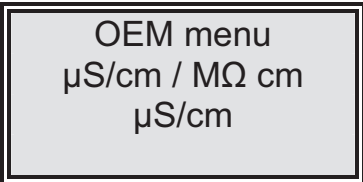

OEM menu
 $\mu\text{S/cm} / \text{M}\Omega \text{ cm}$
 $\mu\text{S/cm}$

11.2.10 Switch off of temperature compensation:**A tenth press on the menu-key:**

Basic setting: on
Setting range: on, off

The display shows:

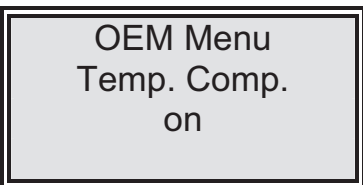

OEM Menu
Temp. Comp.
on

11.2.11 Adjusting the circuit hysteresis of the float switch: An eleventh press on the menu-key:

Basic setting: **Off:** 100 %
 On: 85 %

Setting range: **Off:** 25 - 100 %
 On: 0 - 85 %

With a setting over 100 % for the upper switching point, the display of the tank level is switched off, so that this setting therefore shows whether an analogue or a digital float switch is installed.

The display shows:

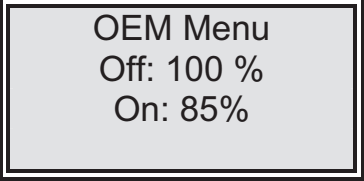

OEM Menu
Off: 100 %
On: 85%

11.2.12 Programme choice UPW/ PW/ EDI: A twelfth press on the menu-key:

The grade of the equipping of the system can be set in this menu to differentiate between UPW, PW and versions.

Basic setting: EDI

The display shows:



OEM Menu
Version
EDI

11.2.13 Entering the type and serial number of the system:

In this menu, the type and serial number of the system can be entered. They are then printed as headline on every print-out. The following types of system can be entered:
Pacific PW / Pacific UP / Pacific UPW / Pacific AFT / Pacific EDI

The display shows:

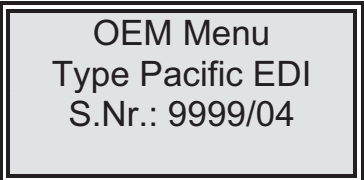

OEM Menu
Type Pacific EDI
S.Nr.: 9999/04

11.3 Printer output

The printer allows various parameters to be recorded. There are 3 different kinds of message:

- Standard message
- Code message
- Fault message

11.3.1 Standard message:

Here a record of all measured values is printed out in dependence on the sending interval. Such a complete data set is also printed out during NONSTOP operation.

Print out:

e.g.: 01.06.07 09:39
 Pacific EDI
 S.No. 9999/04
 TC on UV off
 LF1= 0.062 μ S/cm
 LF2= 9.2 μ S/cm
 Temp.= 11.5 °C

11.3.2 Code message:

Whenever a code number is entered in the controls and confirmed with the Enter-key, then the code input is immediately printed out. For code identification, see the „Assignment Table for code numbers allowing the system to be unlocked“.

Print-out:

e.g.: 01.06.07 10:17
 Pacific EDI
 S.No. 9999/04
 Code 0001

11.3.3 Fault message:

Should a fault message be shown in the display, e.g. the ultrapure water limiting value, then the fault message is printed out at the end of the sending interval.

Print-out:

e.g.: 01.06.07 16:15
 Pacific EDI
 S.No. 9999/04
 Lim.value.ultrapure

12. Maintenance

Your system requires regular, proper and professional maintenance.

We recommend that you close a service contract to ensure that the necessary maintenance work is carried out.

You then have the certainty of a high operational safety and reliability.

The service protocol appended to the service contract serves for certification that maintenance work specified in the contract has been carried out by **TKA** or a service company authorized by **TKA**.



When your system is to work reliably for a long time, it **must** be checked, serviced and cared for at regular time intervals in accordance with these operating instructions!

For this reason, the operating instructions must be readily available to operating and maintenance staff at all times, and be carefully followed!

Please observe that, in accordance with the general terms and conditions of **TKA** company which are the basis for both parties, the guarantee loses its validity when the customer or a third party improperly installs, maintains, repairs, operates, or alters the system, or operates it in an environment which does not fulfil the installation conditions specified by **TKA**.

Any maintenance work which should become necessary during the validity of the guarantee is only to be carried out by **TKA**, or by a customer service which is expressly authorized by **TKA** to do this.

The operating staff assigned is committed to carry out daily/weekly checks. During the agreed term of validity of the guarantee, maintenance is to be carried out weekly according to the maintenance record sheet supplied with the operating instructions.

In so far as the maintenance protocol is not kept up-to-date, or is improperly kept, i.e. without the necessary establishment of data, then the system is deemed to be improperly maintained and the guarantee becomes invalid.

The calibration of the conductivity display is **only** to be carried out and recorded by **TKA** customer service.

Cleaning and disinfection of supply tanks, piping, filter housings etc. is performed for reasons of hygiene and has no effect on the technical condition of the system. These components must be cleaned and disinfected whenever algae/slime are detected inside them or at least once yearly.

The pretreatment included in the system must be replaced two times in the year with the 5µm + activated carbon combi-cartridge (art.-no. 06.5203) and with the hardness stabilizer (art.-no. 06.5453).



When inspection or maintenance work is to be carried out on electrical equipment, then the system is to be separated from the mains by unplugging the line plug and securing it against inadvertent plugging in again. Such work is only to be carried out by trained, skilled electricians.

12.1 Rinsing the membrane

Rinsing out preservative solution:

According to the mode of delivery, the system may be supplied filled with a solution containing a preservative. When putting the system into operation, the permeate must be run to drain for at least 3 – 4 hours after switching to production.



For rinsing and disinfecting, the permeate hose must be drawn off of the outlet of the Ultrapure water system so that the EDI cell does not suffer damage. Connect a hose from the assembly kit to lead off the contaminated permeate from the permeate outlet of the Ultrapure water system to drain.

Unplug the pure system „Power supply EDI“ plug.

Now carry out the rinsing procedure.

When the rinsing and disinfecting process has finished, fit the permeate hose (storage tank) back to the permeate outlet of the Ultrapure water system and re-connect the EDI power supply.

Cleaning the membrane:

Automatic rinsing lengthens the service life of your reverse osmosis module. Coarse particles and other contaminants are swept away from the membrane surface during this rinsing process. The rinsing phases so ensure the longest service and optimal ultrapure water quality.



Leave your ultrapure water system on over the weekend and during holiday times. Only then can the 12-hourly rinse operate and ensure that your reverse osmosis module is not subject to bacterial growth during standstill periods.

Should the performance of your module drop because operation of the system without appropriate pretreatment has resulted in blockage of the membrane, it may well be that your module can be reconditioned.

Reconditioning and disinfection of the module is only to be carried out by authorized service personnel on-site or by sending the module to the manufacturer of your system, whereby exposure to frost must be avoided.

12.2 Replacing the pre-treatment

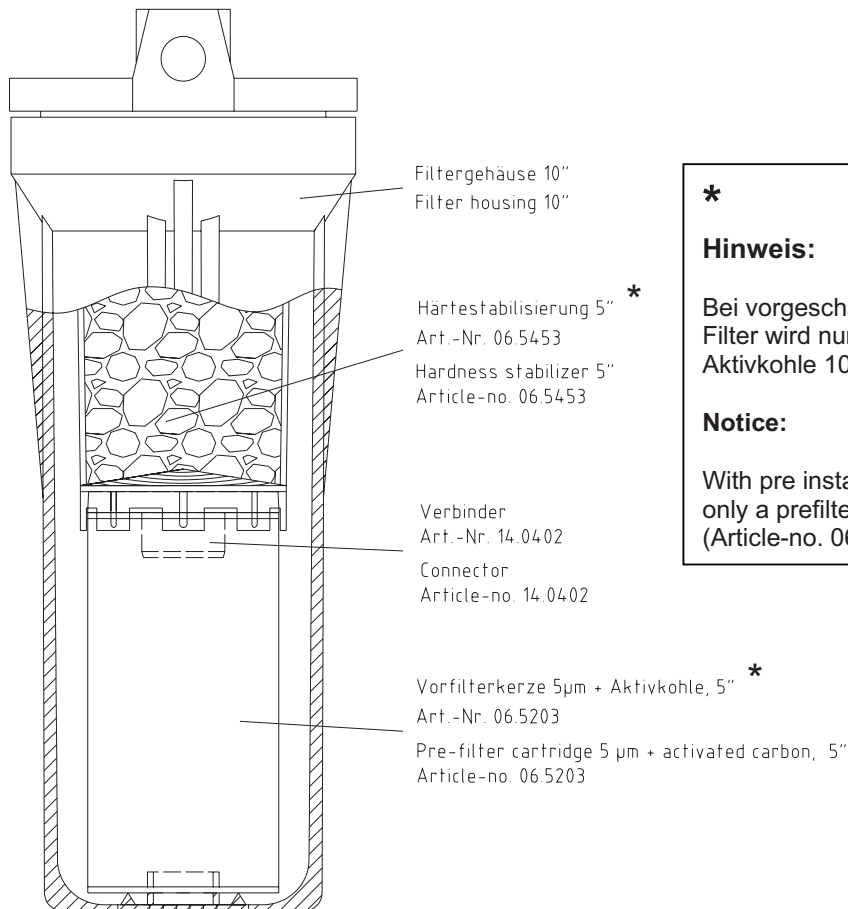

*

Hinweis:

Bei vorgeschaltetem Enthärter oder Mix Multi Filter wird nur eine Vorfilterkerze 5 µm + Aktivkohle 10" (Art.-Nr. 06.5201) eingesetzt.

Notice:

With pre installed Softeners or Mix Multi filter is only a prefilter 5 µm + active carbon 10" (Article-no. 06.5201) inserted.

1. Remove the covering hood from the storage tank.
2. Open the residual drainage of the storage tank, see section "Views and connections", until the Ultrapure water system starts to operate.
3. Stop the supply of feedwater to the Ultrapure water system.
4. Switch the system off.
5. Turn the residual drainage to close it.
6. Screw off the pre-treatment filter housing, see the „Views and connections“ section.
Caution! The filter housing is still filled with water.
7. Removed the spent pre-treatment unit.
8. Connect the new prefilter cartridge and hardness stabilizer together by plugging them with the connector, as shown in the diagram above.
9. Screw the filter housing back on.
10. Open the supply of feedwater to the system.
11. Check that the filter housing does not leak.
12. Switch the Ultrapure water system on.
13. Replace the covering hood on the storage tank.

Your Ultrapure water system is now again ready for use.

12.3 Replacing the RO-membrane

Ansicht von hinten – ohne Rückwand
Back view, with back panel removed

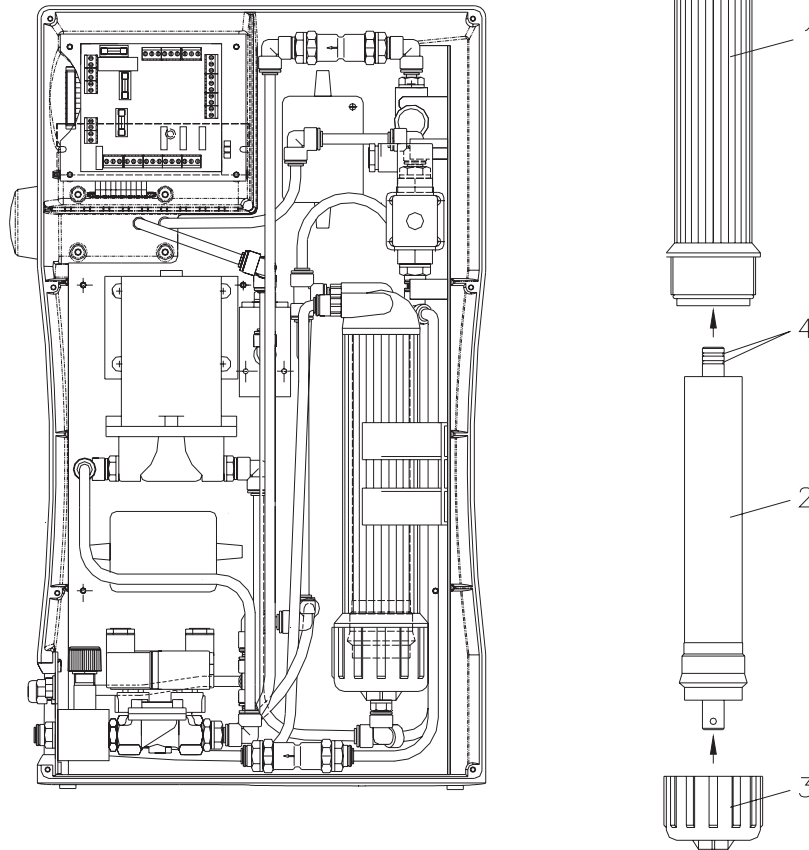

- Remove the line plug from the mains socket.
- Remove the back panel.
- Undo all hose connections to the RO-module pressure tube (1).
- Remove the pressure tube from the holding sleeves.
- Open the cap nut (3) on the pressure tube and remove the RO-membrane (2).
- Insert the new RO-membrane in the pressure tube (1) with the two O-rings (4) on the permeate tube of the RO-module in the direction shown by the arrows.



Inserting the RO-membrane the wrong way round would result in certain destruction of the membrane!

12.4 Changing the Ultrapure water module



The Ultrapure water module must be replaced as soon as the maximum limiting value set for the ultrapure water is exceeded or when the “Change cartridge” message is shown in the display.

Proceed as follows to replace the Ultrapure water module:

1. Switch the system off.
2. Shut off the supply of feedwater.
3. Open the dispensing valve until the flow of water stops, then re-close it.
4. Remove the cartridge cover.
5. Disconnect the quick-connects on the feedwater inlet and purified water outlet of the Ultrapure water module, then close the inlet and outlet with the stoppers which you have kept for later usage.
6. Draw the used Ultrapure water module out from the guide and insert the new module.
7. Remove the stoppers from the new Ultrapure water module and store them for later use.
8. Plug the quick-connects correctly onto the new Ultrapure water module so that they audibly engage.
9. Replace the cartridge cover.
10. Open the supply of feedwater.
11. Switch the system on again.
12. The Ultrapure water system is now again at your availability to produce ultrapure water.

12.5 Disinfection procedure



Disinfection should be regularly carried out, at the latest when the Ultrapure water module is replaced.

A TKA disinfection cartridge (article no.: 09.2201) is required for disinfection of the system.

MICRO-Chlor disinfectant (article no.: 09.2202) are to be used as disinfectant.



To avoid possible health hazards, please take notice of the information given in the safety data sheet supplied in the packaging when handling MICRO-Chlor!

To disinfect the Ultrapure water system proceed as follows:

1. The Ultrapure water system must be in the “Stand by” operating mode.
2. Switch the system off.
3. Turn off the feedwater supply to the system.
4. Open the dispensing valve until water no longer runs out and then close it.
5. Remove the covering hood from the storage tank.
6. Remove the cartridge cover from the system (refer to the “Changing the ultra pure water module” section in the LabTower EDI operating instructions”).
Take off the quick connects from the feedwater and ultra pure water side of the ultra pure water module and close the connectors with the stoppers that you have saved.
7. Remove the ultra pure water module.
8. Take hold of the disinfection cartridge and screw out the stopper from the lid of it. Fill water in through the opening until the cartridge is full and then pour the contents of a can of MICRO-Chlor in.

Important: The cartridge must be completely filled with water for successful disinfection.

9. Screw the stopper back in the lid of the disinfection cartridge and connect up the cartridge in the system (as described in the “Changing the ultra pure water module” section in the operating instructions for the system).
10. Turn the feedwater supply on.
11. Switch the Ultrapure water system on and allow it to run for 2 hours in “Stand by” operating mode.
12. Now open the residual drainage (dispensing valve) of the storage tank and discard all of the water that runs out. Close the residual drainage.
13. Fill the storage tank until the “Stand by” operating mode has been reached and empty the tank as in 12. Repeat this process a second time.



Do not take any water from the dispensing valve or the storage tank during disinfection.

14. Switch the system off.
15. Remove the disinfection cartridge and fit in the new ultra pure water module.
16. Switch the system off.
17. Finally replace the covering hood on the storage tank.

18. The Ultrapure water system is now again at your availability to produce ultrapure water.



Always install a new filter element in the pretreatment and a new ultrapure water module following disinfection of the system.

The 0,2 µm sterile vent filter can be autoclaved if required.

Replacement parts:

Ultrapure water module
Sterile vent filter, 0,2 µm

Article no: 09.2005

Article no: 06.5003

or

Sterile vent filter, 0,2 µm + CO₂ (option)

Article no: 06.5002

13. Trouble shooting

Fault	Cause	Remedy
The system does not start	- No supply of power	- Connect to power supply
No dispensing possible	<ul style="list-style-type: none"> - Feedwater tap is closed - Feedwater and rinse water connections the wrong way round - Feedwater pressure < 1.5 - bar 	<ul style="list-style-type: none"> - Open feedwater tap - Reverse the connections - Increase feedwater pressure
Conductivity too high	- Ion exchanger capacity is - exhausted	- Replace ion exchanger with a new one
System control no longer reacts	- Improper operation	- Remove line plug for 5 seconds
Water flows out	<ul style="list-style-type: none"> - Leaky hose connection - Feedwater pressure > 6 bar 	<ul style="list-style-type: none"> - Check and hose connection - and stop the leak - Install a pressure reducer, - possibly operate via the - emergency supply
Permeate flow too low (-15%)	<ul style="list-style-type: none"> - Blocked membrane - Precompression too low - Feedwater temperature - fluctuates 	<ul style="list-style-type: none"> - Clean the membrane - Increase precompression
Wrong time or date	- Time zone Summer/Winter time	- Reset time and date
Wrong language	- Wrong language set	- Set wanted language

<p>Fault message: <i>Lim.val.permeate"</i></p>	<ul style="list-style-type: none"> - The conductivity of the - permeate is too high - The limiting value is set too low - The membrane is blocked 	<ul style="list-style-type: none"> - Check the pre-treatment - Check and re-adjust the limiting value setting - Replace the membrane
<p>Fault message: <i>Lim.val.EDI"</i></p>	<ul style="list-style-type: none"> - The conductivity of the - product water is too high - The limiting value is set too low - The EDI cell is damaged 	<ul style="list-style-type: none"> - Check the permeate conductivity - Check and re-adjust the limiting value setting - Replace the EDI cell
<p>Fault message: <i>"Lim.val.pure w"</i></p>	<ul style="list-style-type: none"> - The limiting value is set too low 	<ul style="list-style-type: none"> - Check and re-adjust the limiting value setting
<p>Fault message: <i>"UV-time"</i></p>	<ul style="list-style-type: none"> - The operating hours of the - UV-lamp have been exceeded 	<ul style="list-style-type: none"> - Replace the UV-Lamp (art.- no. 09.2002) and set back - the operating hours counter
<p>Fault message: <i>"Measuring cell LF1"</i></p>	<ul style="list-style-type: none"> - Cable break at the measuring cell - System control defect - Ultrapure water conductivity outside of measuring range 	<ul style="list-style-type: none"> - Replace the measuring cell - Replace the system control - see "Lim.val.pure w"
<p>Fault message: <i>"Measuring cell LF2"</i></p>	<ul style="list-style-type: none"> - Cable break at the measuring cell - System control defect - Feedwater conductivity - outside of measuring range 	<ul style="list-style-type: none"> - Replace the measuring cell - Replace the system control - see "Lim.val.permeate"

<p>Fault message: <i>"Measuring cell LF3"</i></p>	<ul style="list-style-type: none"> - Cable break at the measuring cell - System control defect - EDI conductivity outside of measuring range 	<ul style="list-style-type: none"> - Replace the measuring cell - Replace the system control - see "Lim.val.EDI"
<p>Fault message: <i>"Measuring cell Temp."</i></p>	<ul style="list-style-type: none"> - Cable break at the measuring cell - System control defect 	<ul style="list-style-type: none"> - Replace the measuring cell - Replace the system control

The address to contact should you need service:

TKA Wasseraufbereitungssysteme GmbH
Stockland 3
D-56412 Niederelbert

Tel. No.: +49 (0)26 02 1 06 99-0
Fax. No.: +49 (0)26 02 1 06 99-50
Internet: www.tka.de
E-Mail: info@tka.de

14. List of replacement parts

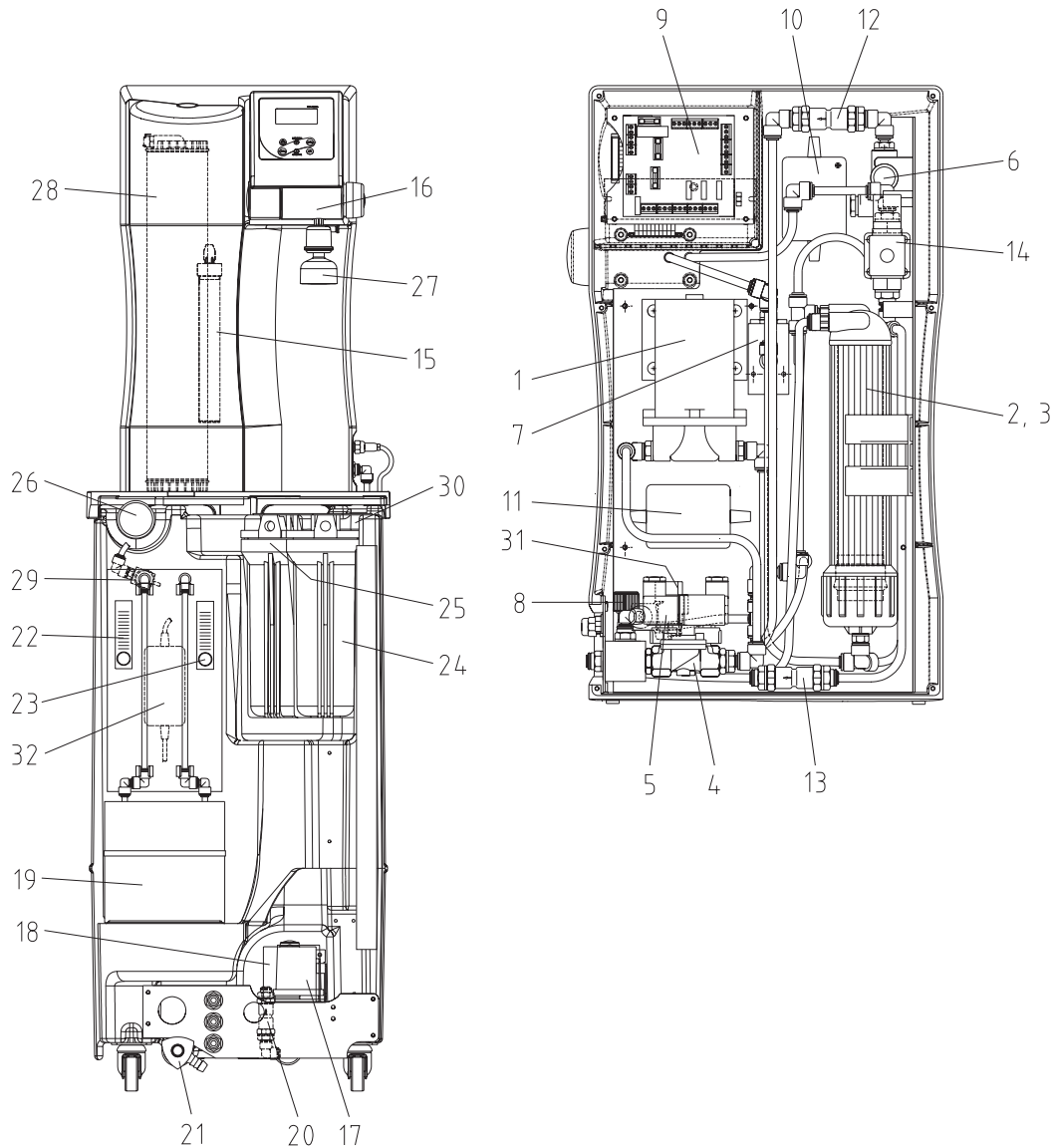

No.	R+I No.	Article designation	Art.-no.
1	P1	Pressure booster pump RO for system 15 L/h Pressure booster pump RO for system 30+45 L/h	19.0046* 19.0050*
2,3	F2	Reverse osmosis membrane, for system 15, L/h 2x Reverse osmosis membrane, for system 30+45, L/h 2x Module pressure tube, for system 15 – 45 L/h 2x	22.0046* 22.0087* 22.0047
4	V1	Inlet solenoid valve	15.0103*
5	V3	Rinsing solenoid valve	15.0103*
6	QIA300	Measuring cell permeate	16.0126
7	QIA302 TIA500	Measuring cell ultrapure water	26.0014
8	V2	Pressure hold valve	15.0060
9		Microprocessor system control, complete	26.0023

10		Transformer for: Pressure booster pump P1, system 15 l/h Pressure booster pump P1, system 30+45 l/h	16.0195 on request
11		Transformer for recirculation pump	16.0195
12	V4	Check valve	15.0009
13	V5	Check valve	15.0019
14	V6	Recirculation solenoid valve	15.0014*
15	UV1	UV-Lamp in system (option)	09.2002
16	V7	Dispensing valve	25.0068
17	PS200	Pressure switch	15.0058*
18	P2	Circulation pump	19.0046*
19	EDI	EDI-Cell	22.0098
20	V11	Check valve	15.0009
21	V10	Dispensing tap	14.0250
22	FI400 + V8	Flowmeter, product (EDI) incl. regulation valve	15.0123
23	FI401 + V9	Flowmeter, concentrate (EDI) incl. regulation valve	15.0124
24	F1	Pre-treatment consisting of: Prefilter cartridge 5µm + Activated carbon, 5" Hardness stabilizer, 5" Connector	06.5203 06.5453 14.0402
		With pre installed Softener or Mix Multi filter Prefilter cartridge 5µm + Activated carbon, 10"	06.5201
25	F6	Fine filter 1µm-10" or Sterile filter 0.1µm-10" (option)	06.5101 06.5557
		Sterile vent filter 0.2µm or Sterile vent filter 0.2µm + CO ₂ Adsorber (option)	06.5003 06.5002
26	F5	Sterile vent filter 0.2µm or Sterile vent filter 0.2µm + CO ₂ Adsorber (option)	06.5003 06.5002
27	F4	Ultra filtration capsule (option)	09.1021
28	F3	Ultrapure water module	09.2005
29	QIA301	Measuring cell product water	26.0047
30	LIS100	Level control	16.0355
31	PS201	Pressure switch rawwater	15.0099*
32	EDI	Transformer/EDI	16.0334
	V12	Sterile overflow/storage tank (option)	15.0009

* Wearing part

We ask for your understanding that the guarantee we give becomes invalid when replacement parts, accessories or consumables from other manufacturers are used, as we have no influence on their appropriateness or quality.

15. Accessories

➤ UV-Lamp (in system)	Article no.:	26.0013
➤ UV-Lamp (in tank)	Article no.:	06.5006
➤ Sterile filter cartridge 10"	Article no.:	06.5557
➤ Sterile vent filter	Article no.:	06.5003
➤ Sterile vent filter + CO ₂ Adsorber	Article no.:	06.5002
➤ Sterile overflow	Article no.:	15.0009
➤ Sterile filter capsule 0.2 µm	Article no.:	09.1003
➤ Ultra filtration capsule	Article no.:	09.1021

16. Consumable materials:

Pre-treatment:

➤ Prefilter cartridge 5µm + Activated carbon, 5"	Article no.:	06.5203
➤ Hardness stabilizer, 5"	Article no.:	06.5453
➤ Connector	Article no.:	14.0402
➤ Prefilter cartridge 5µm + Activated carbon, 10" (only with upstream softener)	Article no.:	06.5201
➤ Ultrapure water module	Article no.:	09.2005
➤ Ultra filtration capsule	Article no.:	09.1021
➤ Sterile vent filter	Article no.:	06.5003
➤ Sterile vent filter + CO ₂ Adsorber	Article no.:	06.5002
➤ Sterile filter cartridge 1µm-10"	Article no.:	06.5557
➤ Fine filter 1µm-10"	Article no.:	06.5101

UV-Lamp - System:

➤ Replacement UV-lamp	Article no.:	09.2002
➤ Immersion tube	Article no.:	22.0063

UV-Lamp – Storage tank:

➤ Replacement UV-lamp	Article no.:	09.5002
➤ Immersion tube	Article no.:	22.0096

17. Terminal assignment

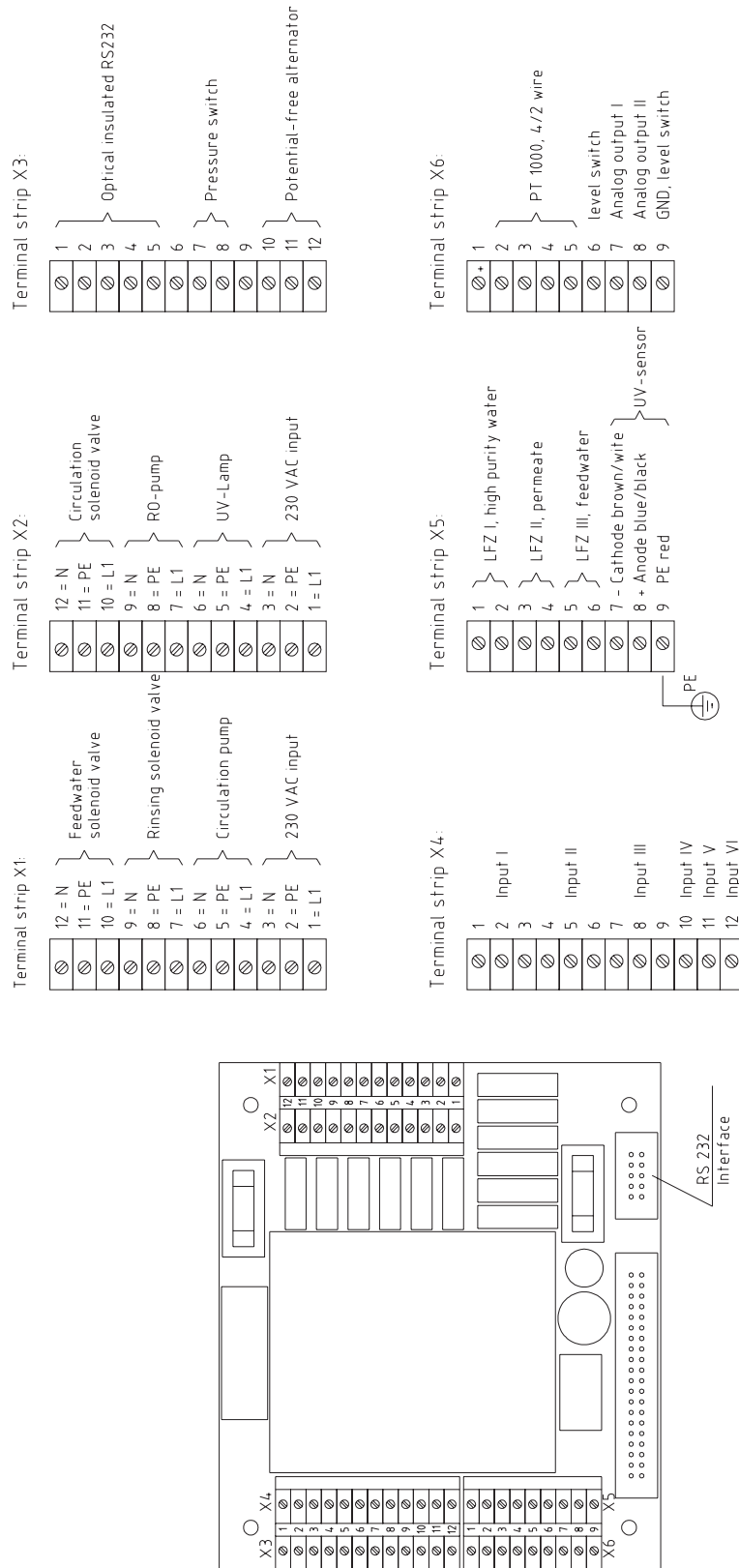

Distributed by:



Carl Stuart Limited

ADVANCED APPLIED TECHNOLOGIES

Contact Us:

Irl Ph: 01 4523432

UK Ph: 08452 30 40 30

Web: www.carlstuart.com

Email: info@carlstuart.com

18. Maintenance record

(Please note that correct keeping of this record is a condition for the validity of the guarantee)

Customer address: _____ **Location:** _____ **System type:** _____

_____ **Serial no.:** _____

_____ **Year made:** _____

Date	Conductivity Permeate [μS/cm]	Conductivity EDI [μS/cm]	Conductivity Ultrapure water [μS/cm]	Product EDI [L/h]	Concentrate EDI [L/h]	Operating hours RO [h]

Change of prefilter yes/no	Change of hardness stabilizer yes/no	Change of sterile filter or fine filter yes/no	Change of ultrapure water module yes/no	Remarks	Signature

Any false entry is considered to be a falsification of documents.

The following points are to be observed to ensure the quality of the system:

- 1 each week, record measured values
- Every 3 - 6 months* - change the hardness stabilizer
- Every 3 - 6 months* - change the prefilter

*According to the quality of the feedwater